

INTERNAL HEXAGON UNIVERSAL CONNECTION

TAPERED SHAPE

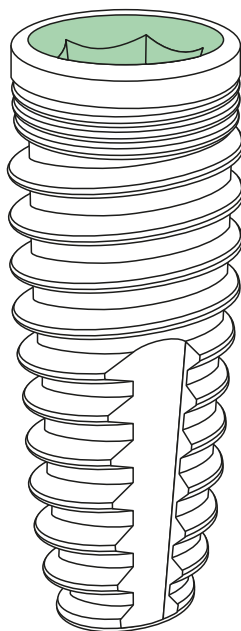

IK

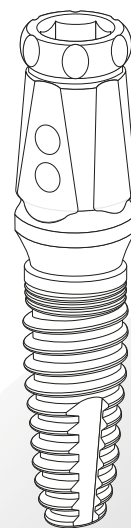

IMPIANTO
CON MOUNTER
WITH MOUNTER

IK 34

K-TAPERED internal hexagon - full treatment

TAPERED SHAPE

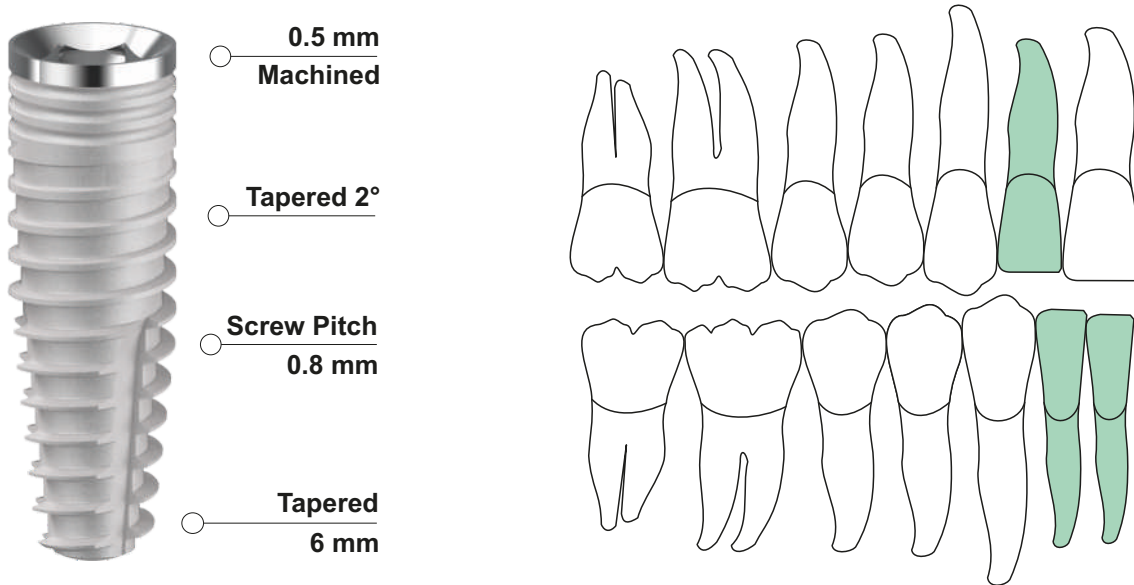

CODE	IMPLANT	LENGTH	PLATFORM	APEX
IK 3407	Ø 3.4	7.0 mm	Ø 3.5 CPS	Ø 1.7
IK 3408	Ø 3.4	8.5 mm	Ø 3.5 CPS	Ø 1.7
IK 3410	Ø 3.4	10 mm	Ø 3.5 CPS	Ø 1.7
IK 3411	Ø 3.4	11.5 mm	Ø 3.5 CPS	Ø 1.7
IK 3413	Ø 3.4	13 mm	Ø 3.5 CPS	Ø 1.7
IK 3415	Ø 3.4	15 mm	Ø 3.5 CPS	Ø 1.7

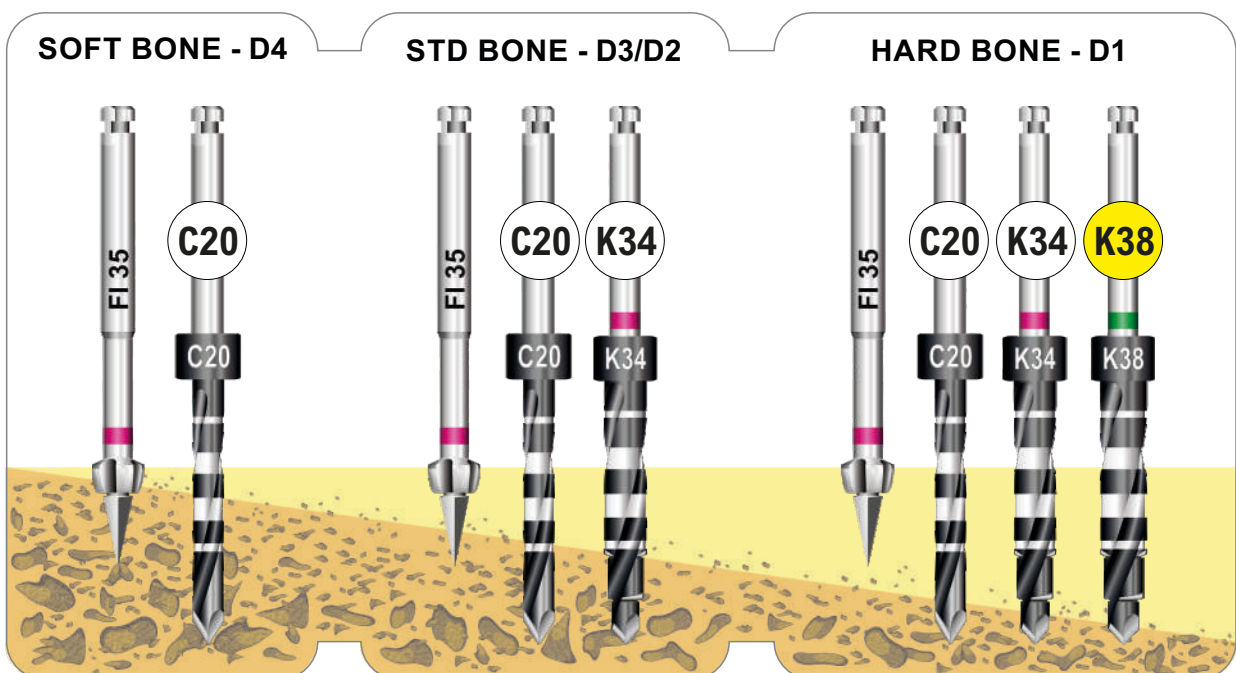

K-TAPERED

internal hexagon - full treatment

IK 38

TAPERED SHAPE

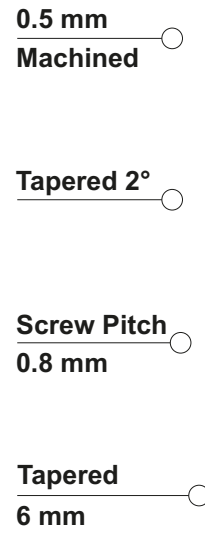
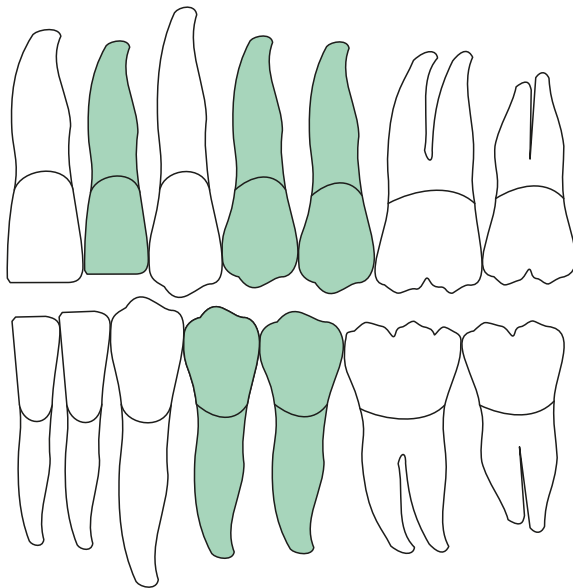

CODE	IMPLANT	LENGTH	PLATFORM	APEX
IK 3808	Ø 3.8	8.5 mm	Ø 4.0	Ø 1.8
IK 3810	Ø 3.8	10 mm	Ø 4.0	Ø 1.8
IK 3811	Ø 3.8	11.5 mm	Ø 4.0	Ø 1.8
IK 3813	Ø 3.8	13 mm	Ø 4.0	Ø 1.8
IK 3815	Ø 3.8	15 mm	Ø 4.0	Ø 1.8

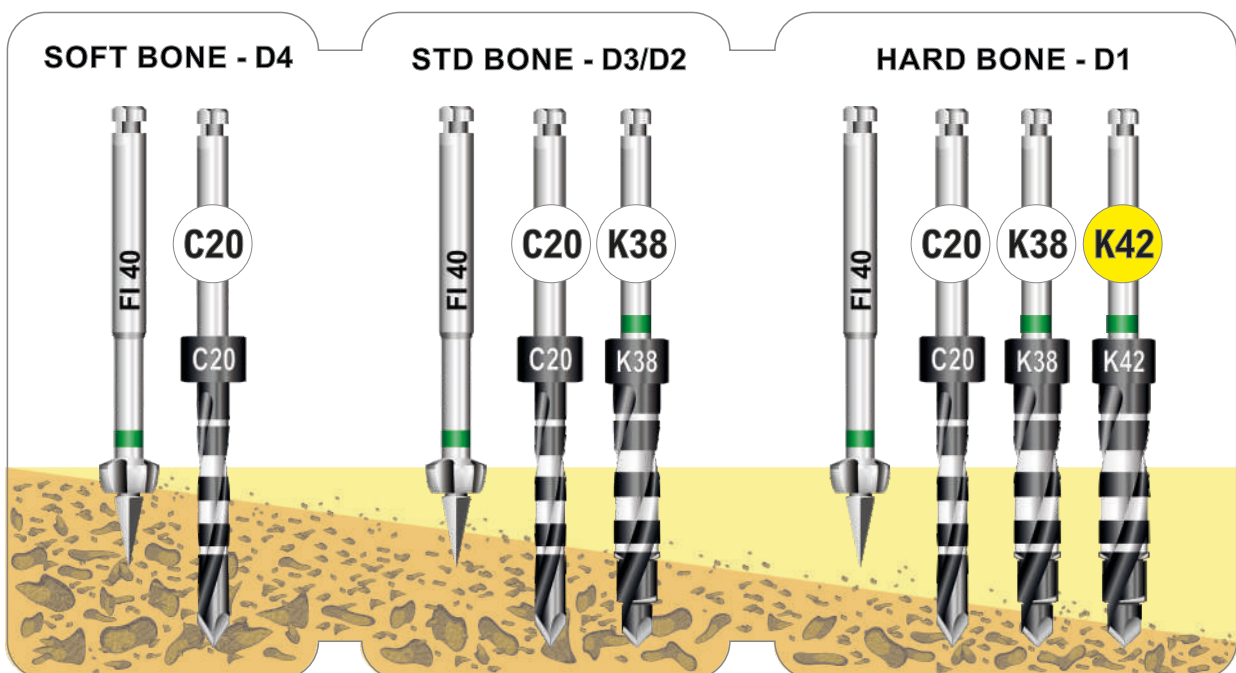

IK 42

K-TAPERED internal hexagon - full treatment

TAPERED SHAPE

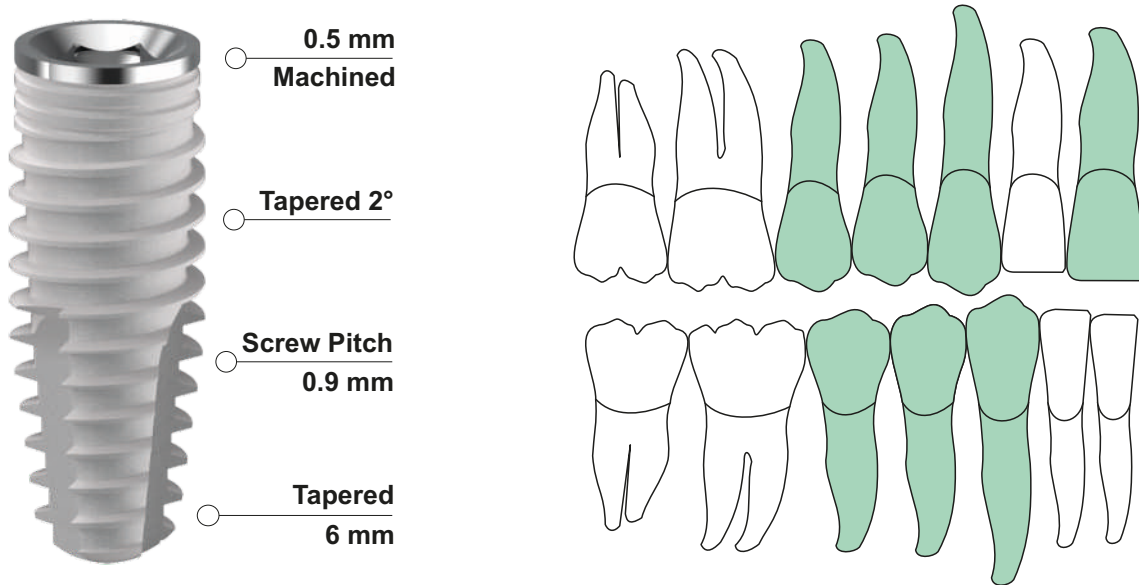

CODE	IMPLANT	LENGTH	PLATFORM	APEX
IK 4207	Ø 4.2	7.0 mm	Ø 4.0	Ø 2.2
IK 4208	Ø 4.2	8.5 mm	Ø 4.0	Ø 2.2
IK 4210	Ø 4.2	10 mm	Ø 4.0	Ø 2.2
IK 4211	Ø 4.2	11.5 mm	Ø 4.0	Ø 2.2
IK 4213	Ø 4.2	13 mm	Ø 4.0	Ø 2.2
IK 4215	Ø 4.2	15 mm	Ø 4.0	Ø 2.2

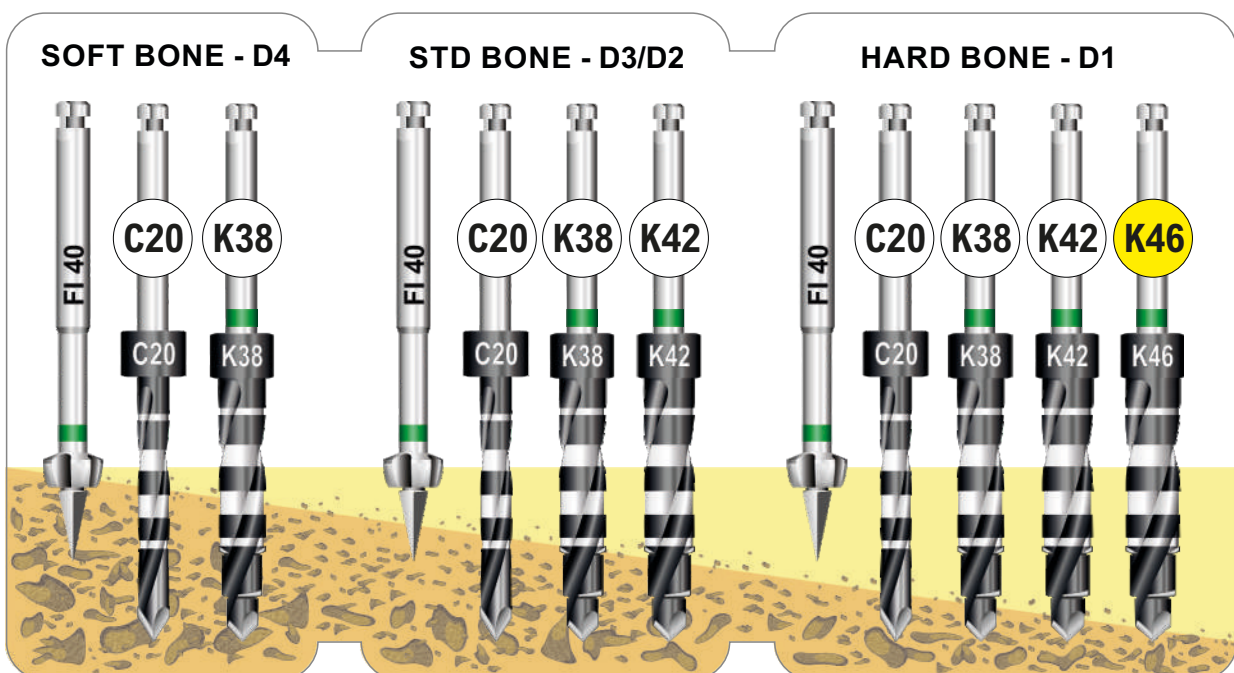

K-TAPERED

internal hexagon - full treatment

IK 46

TAPERED SHAPE

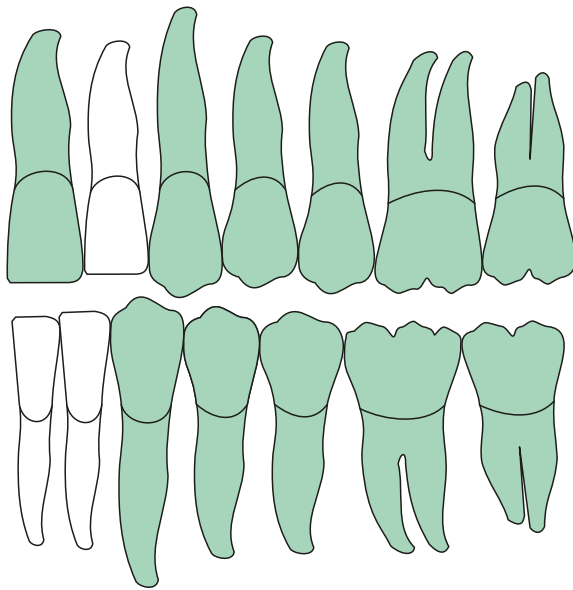

0.5 mm
Machined

Tapered 2°

Screw Pitch
1.0 mm

Tapered
6 mm



CODE	IMPLANT	LENGTH	PLATFORM	APEX
IK 4607	Ø 4.6	7.0 mm	Ø 4.0	Ø 2.6
IK 4608	Ø 4.6	8.5 mm	Ø 4.0	Ø 2.6
IK 4610	Ø 4.6	10 mm	Ø 4.0	Ø 2.6
IK 4611	Ø 4.6	11.5 mm	Ø 4.0	Ø 2.6
IK 4613	Ø 4.6	13 mm	Ø 4.0	Ø 2.6
IK 4615	Ø 4.6	15 mm	Ø 4.0	Ø 2.6

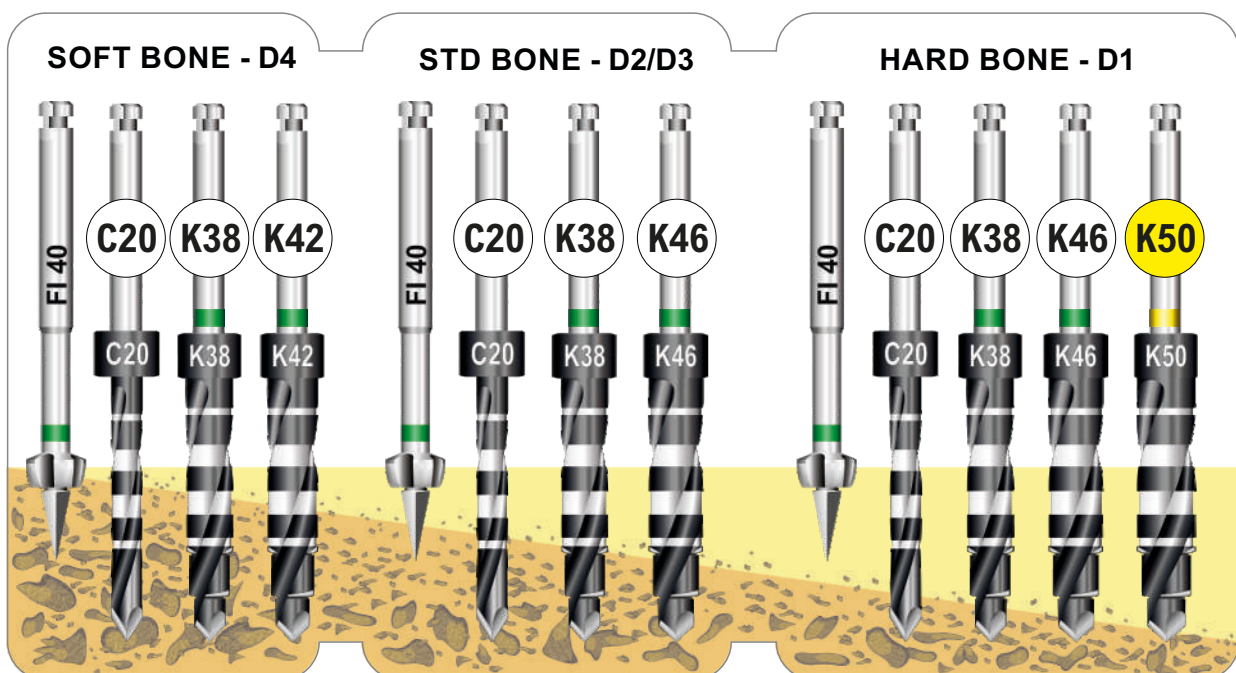

IK 34 HT

K-TAPERED HT
internal hexagon - half treatment

TAPERED SHAPE

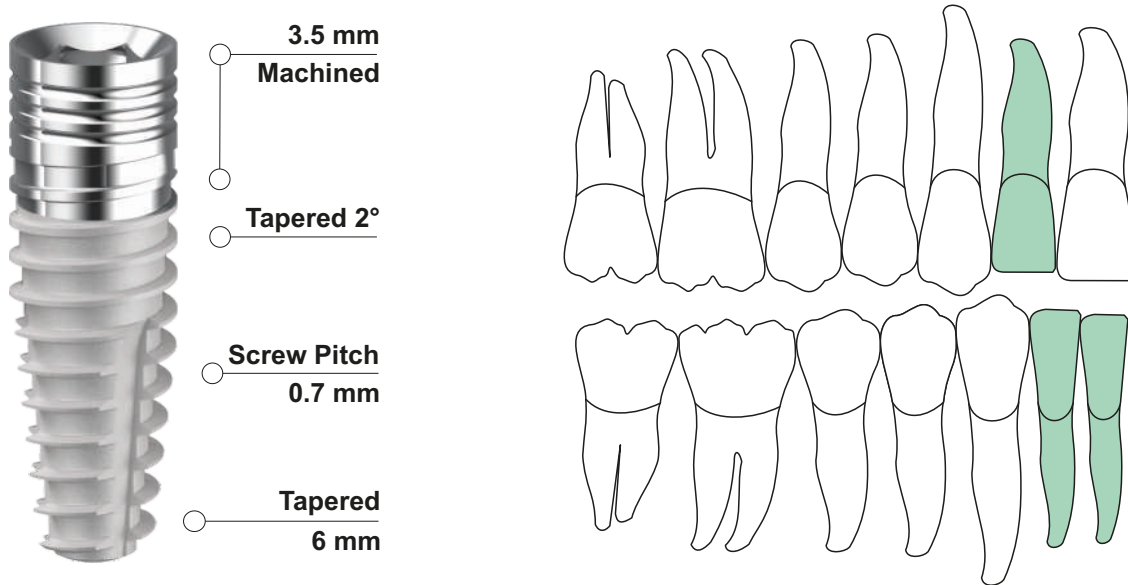

CODE	IMPLANT	LENGTH	PLATFORM	APEX
IK 3408 HT	Ø 3.4	8.5 mm	Ø 3.5 CPS	Ø 1.7
IK 3410 HT	Ø 3.4	10 mm	Ø 3.5 CPS	Ø 1.7
IK 3411 HT	Ø 3.4	11.5 mm	Ø 3.5 CPS	Ø 1.7
IK 3413 HT	Ø 3.4	13 mm	Ø 3.5 CPS	Ø 1.7
IK 3415 HT	Ø 3.4	15 mm	Ø 3.5 CPS	Ø 1.7

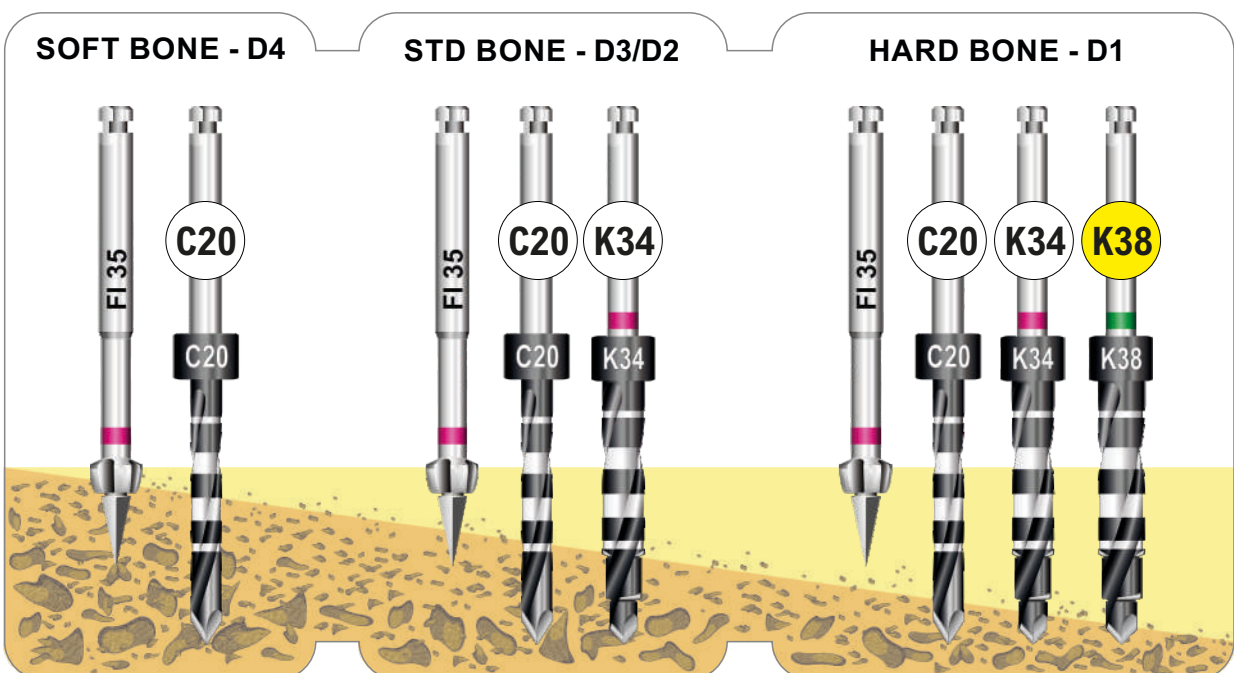

K-TAPERED HT
internal hexagon - half treatment

IK 38 HT

TAPERED SHAPE

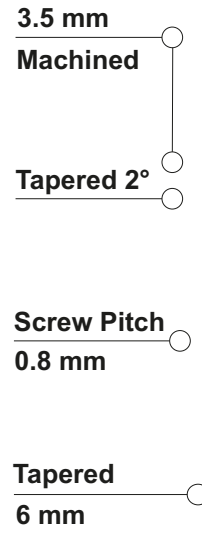
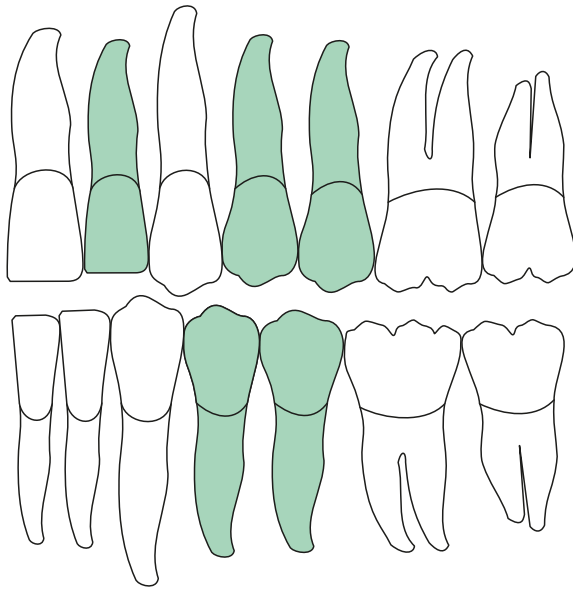

CODE	IMPLANT	LENGTH	PLATFORM	APEX
IK 3808 HT	Ø 3.8	8.5 mm	Ø 4.0	Ø 1.8
IK 3810 HT	Ø 3.8	10 mm	Ø 4.0	Ø 1.8
IK 3811 HT	Ø 3.8	11.5 mm	Ø 4.0	Ø 1.8
IK 3813 HT	Ø 3.8	13 mm	Ø 4.0	Ø 1.8
IK 3815 HT	Ø 3.8	15 mm	Ø 4.0	Ø 1.8

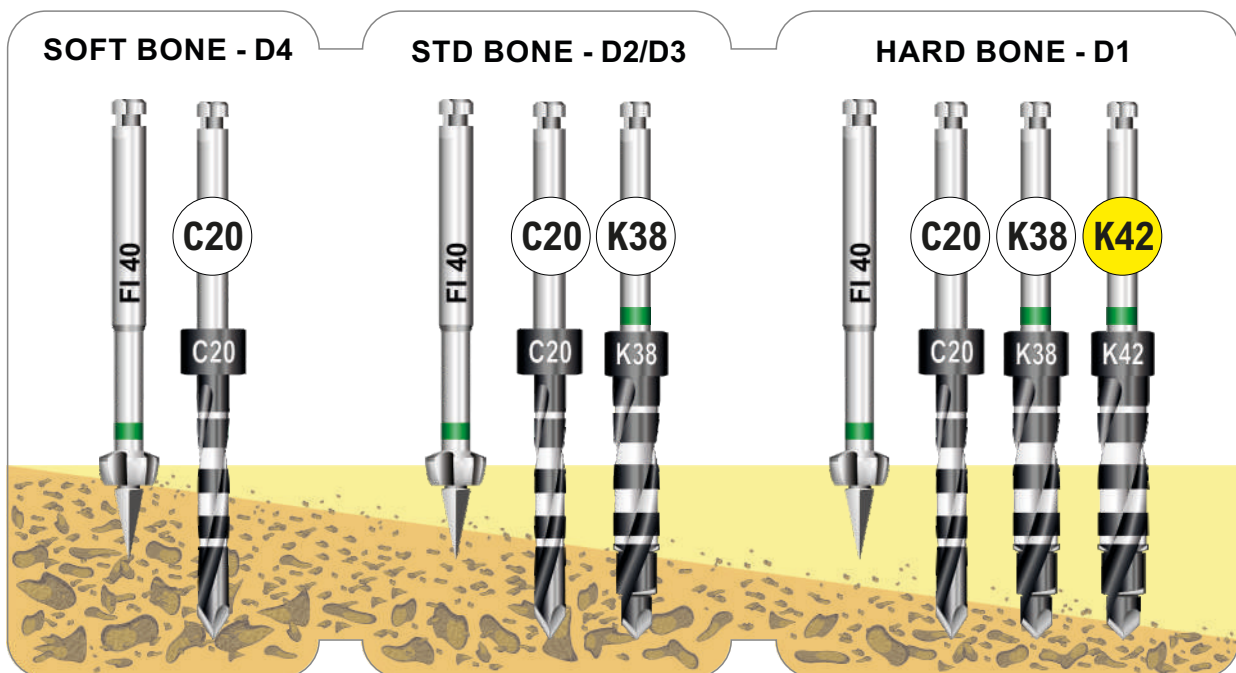

IK 42 HT

K-TAPERED HT
internal hexagon - half treatment

TAPERED SHAPE

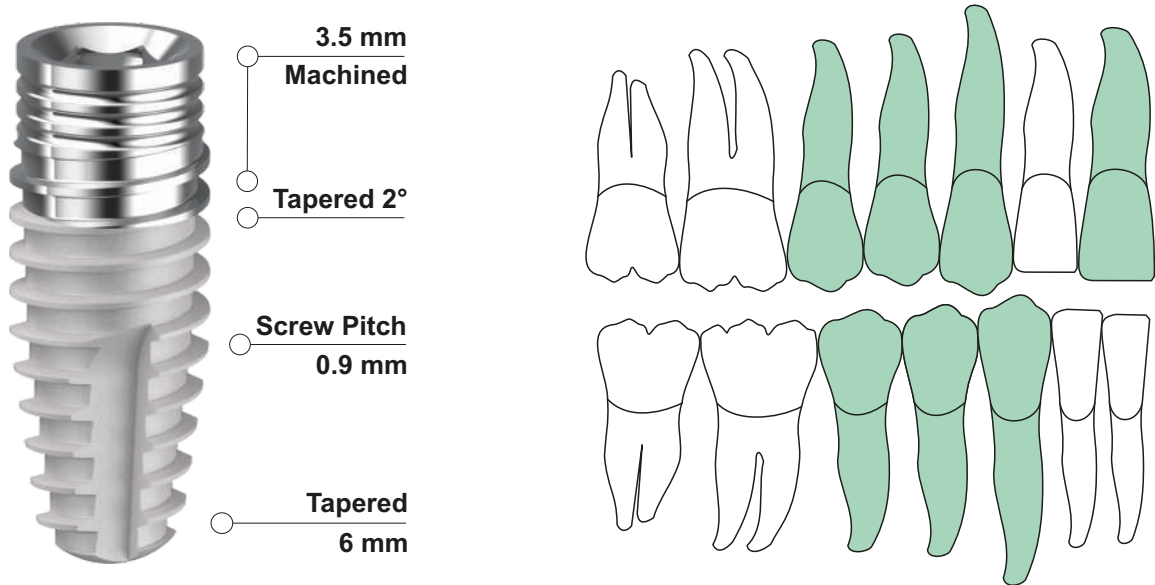

CODE	IMPLANT	LENGTH	PLATFORM	APEX
IK 4208 HT	Ø 4.2	8.5 mm	Ø 4.0	Ø 2.2
IK 4210 HT	Ø 4.2	10 mm	Ø 4.0	Ø 2.2
IK 4211 HT	Ø 4.2	11.5 mm	Ø 4.0	Ø 2.2
IK 4213 HT	Ø 4.2	13 mm	Ø 4.0	Ø 2.2
IK 4215 HT	Ø 4.2	15 mm	Ø 4.0	Ø 2.2

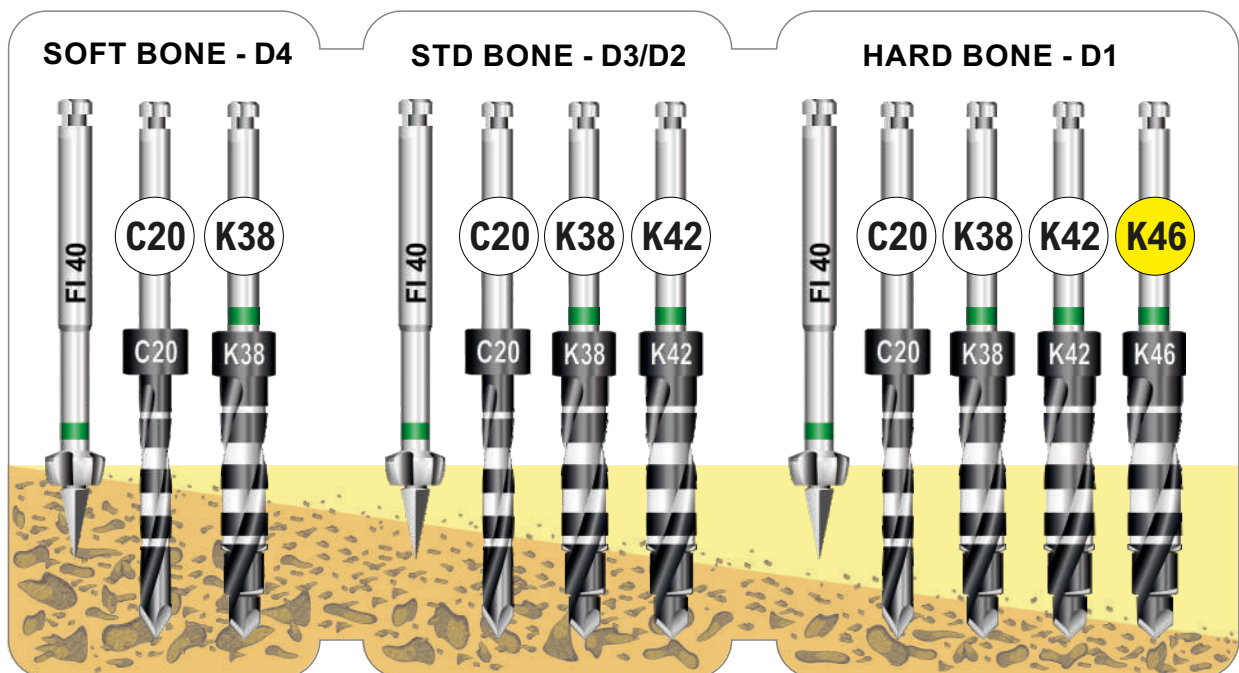

K-TAPERED HT

internal hexagon - half treatment

IK 46 HT

TAPERED SHAPE

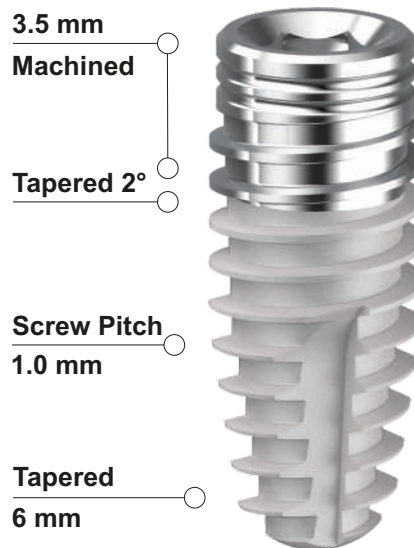
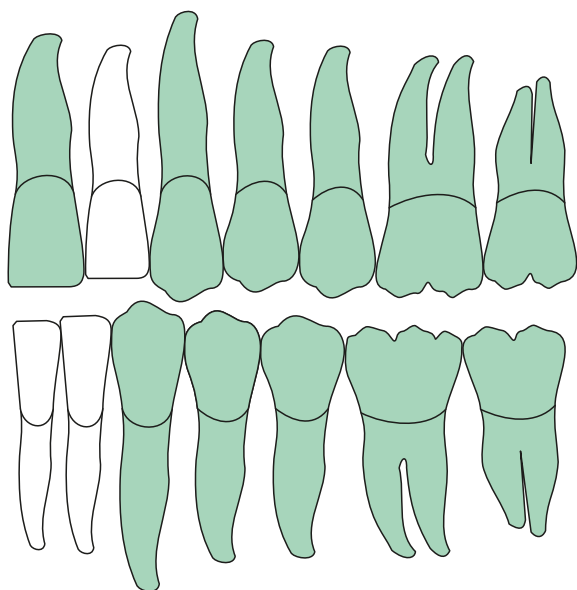

CODE	IMPLANT	LENGTH	PLATFORM	APEX
IK 4608 HT	Ø 4.6	8.5 mm	Ø 4.0	Ø 2.6
IK 4610 HT	Ø 4.6	10 mm	Ø 4.0	Ø 2.6
IK 4611 HT	Ø 4.6	11.5 mm	Ø 4.0	Ø 2.6
IK 4613 HT	Ø 4.6	13 mm	Ø 4.0	Ø 2.6
IK 4615 HT	Ø 4.6	15 mm	Ø 4.0	Ø 2.6

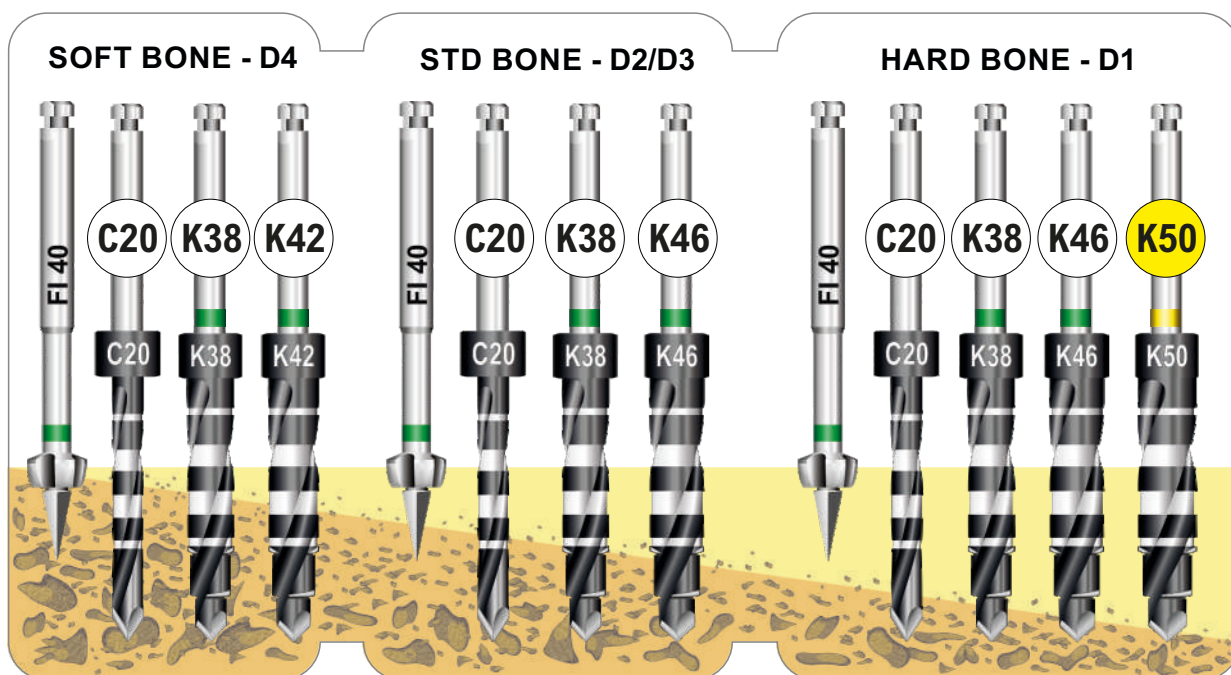



INTERNAL HEXAGON

WIDE PLATFORM

DOUBLE CONNECTION

LARGE TAPERED
SHAPE

UNIVERSAL

WIDE

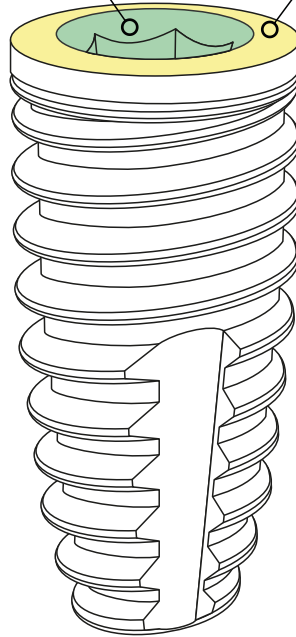

IK

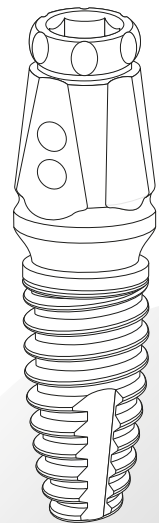

IMPIANTO
CON MOUNTER
WITH MOUNTER

IK 50

K-TAPERED internal hexagon - full treatment

LARGE TAPERED SHAPE

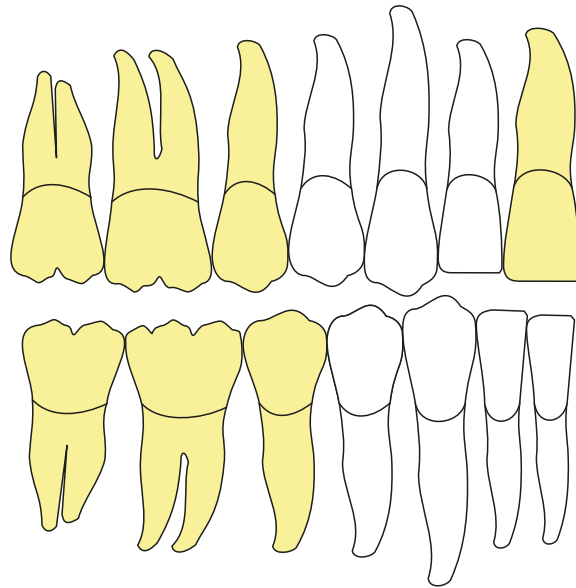

CODE	IMPLANT	LENGTH	PLATFORM	APEX
IK 5007	Ø 5.0	7.0 mm	Ø 5.0	Ø 3.3
IK 5008	Ø 5.0	8.5 mm	Ø 5.0	Ø 3.3
IK 5010	Ø 5.0	10 mm	Ø 5.0	Ø 3.3
IK 5011	Ø 5.0	11.5 mm	Ø 5.0	Ø 3.3
IK 5013	Ø 5.0	13 mm	Ø 5.0	Ø 3.3

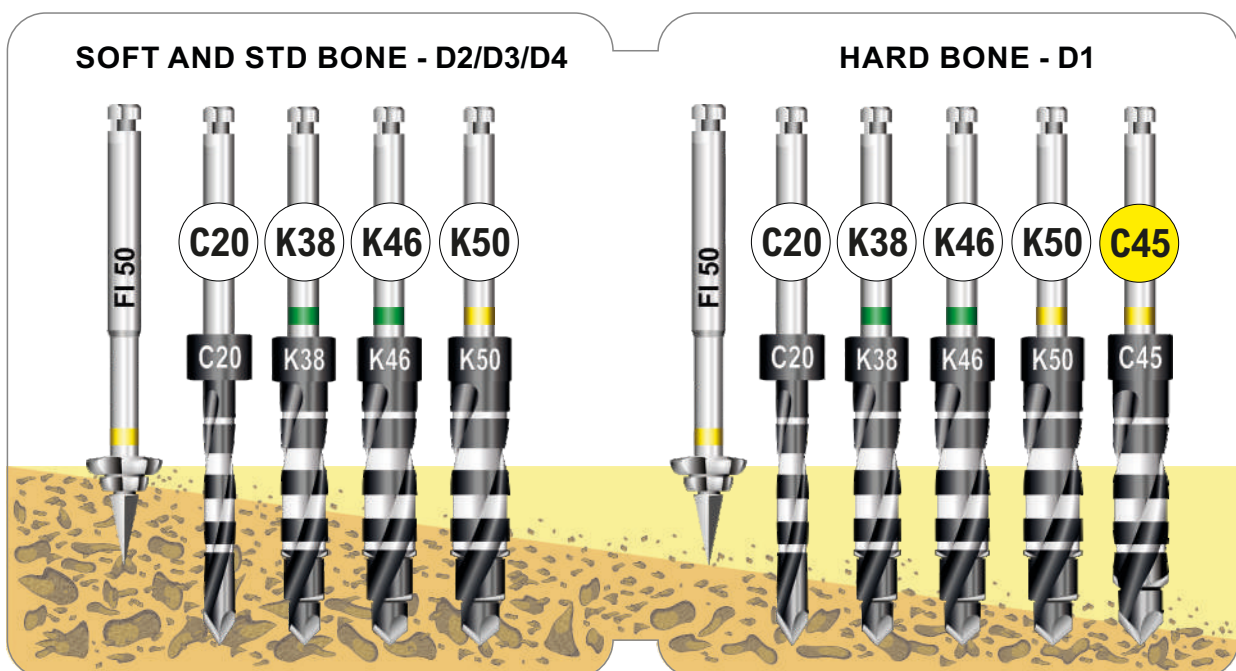

K-TAPERED HT

internal hexagon - half treatment

IK 50 HT

LARGE TAPERED SHAPE

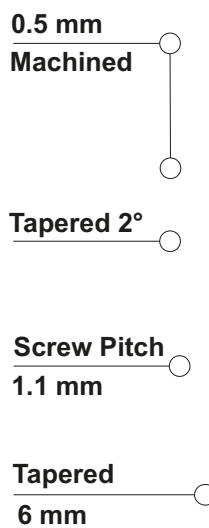
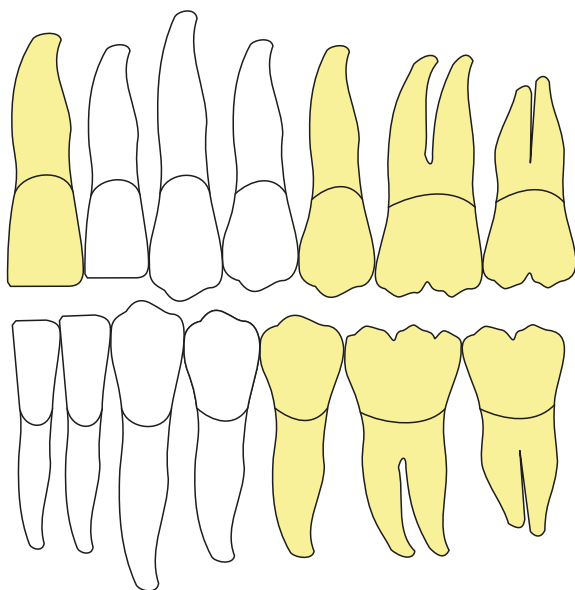

CODE	IMPLANT	LENGTH	PLATFORM	APEX
IK 5008 HT	Ø 5.0	8.5 mm	Ø 5.0	Ø 3.3
IK 5010 HT	Ø 5.0	10 mm	Ø 5.0	Ø 3.3
IK 5011 HT	Ø 5.0	11.5 mm	Ø 5.0	Ø 3.3
IK 5013 HT	Ø 5.0	13 mm	Ø 5.0	Ø 3.3

SOFT AND STD BONE - D2/D3/D4



HARD BONE - D1

